

TANDEMBOX – Auszugssystem

▶ ORGA-LINE für TANDEMBOX

▶▶ Zubehör – ORGA-LINE

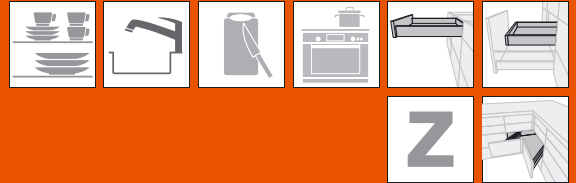

TANDEMBOX

Besteckeinsatz

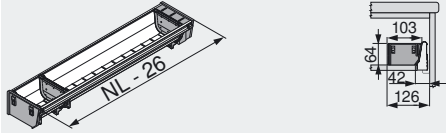

Nennlänge NL	Art.-Nr.
450 mm	ZSI.450BI1N
500 mm	ZSI.500BI1N
550 mm	ZSI.550BI1N
600 mm	ZSI.600BI1N
650 mm	ZSI.650BI1N

Besteckeinsatz

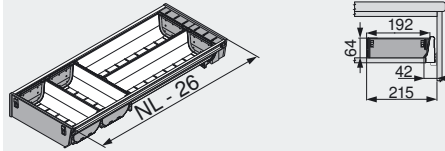

Nennlänge NL	Art.-Nr.
450 mm	ZSI.450BI2N
500 mm	ZSI.500BI2N
550 mm	ZSI.550BI2N
600 mm	ZSI.600BI2N
650 mm	ZSI.650BI2N

Besteckeinsatz

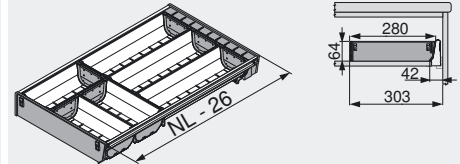

Nennlänge NL	Art.-Nr.
450 mm	ZSI.450BI3N
500 mm	ZSI.500BI3
550 mm	ZSI.550BI3
600 mm	ZSI.600BI3
650 mm	ZSI.650BI3

Facheinteilung

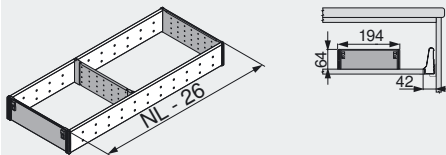

Messerhalter (Optional) ZSZ.02M0	
Nennlänge NL	Art.-Nr.
450 mm	ZSI.450FI2N
500 mm	ZSI.500FI2N
550 mm	ZSI.550FI2N
600 mm	ZSI.600FI2N
650 mm	ZSI.650FI2N

Facheinteilung

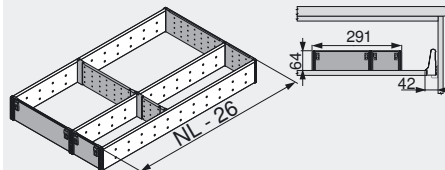

Messerhalter (Optional) ZSZ.02M0	
Nennlänge NL	Art.-Nr.
450 mm	ZSI.450FI3
500 mm	ZSI.500FI3
550 mm	ZSI.550FI3
600 mm	ZSI.600FI3
650 mm	ZSI.650FI3

Besteckeinsatz und Facheinteilung

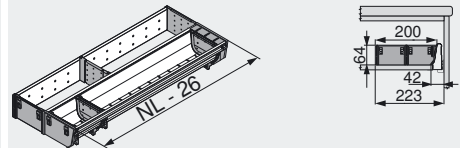

Nennlänge NL	Art.-Nr.
450 mm	ZSI.450KI2N
500 mm	ZSI.500KI2N
550 mm	ZSI.550KI2N
600 mm	ZSI.600KI2N
650 mm	ZSI.650KI2N

Besteckeinsatz und Facheinteilung

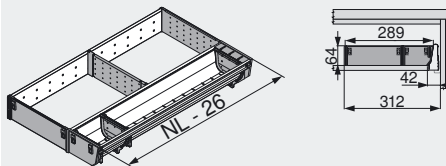

Messerhalter (Optional) ZSZ.02M0	
Nennlänge NL	Art.-Nr.
450 mm	ZSI.450KI3N
500 mm	ZSI.500KI3N
550 mm	ZSI.550KI3N
600 mm	ZSI.600KI3N
650 mm	ZSI.650KI3N

Besteckeinsatz und Facheinteilung

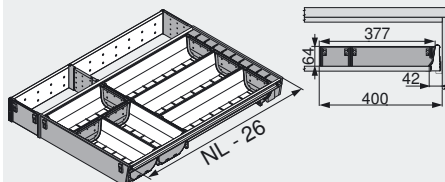

Nennlänge NL	Art.-Nr.
450 mm	ZSI.450KI4N
500 mm	ZSI.500KI4
550 mm	ZSI.550KI4
600 mm	ZSI.600KI4
650 mm	ZSI.650KI4

Besteckeinsatz und Facheinteilung

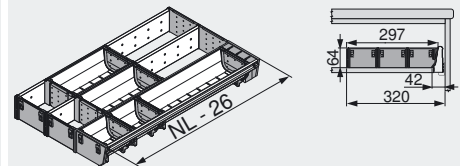

Nennlänge NL	Art.-Nr.
450 mm	ZSI.450MI3
500 mm	ZSI.500MI3
550 mm	ZSI.550MI3
600 mm	ZSI.600MI3
650 mm	ZSI.650MI3

TANDEMBOX – Auszugssystem

► ORGA-LINE für TANDEMBOX

►► Zubehör – ORGA-LINE

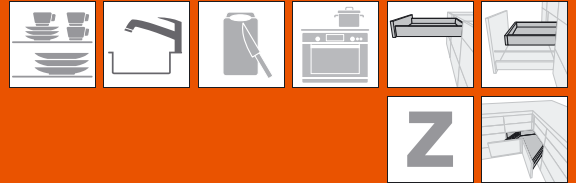

SPACE CORNER-Besteckeinsatz

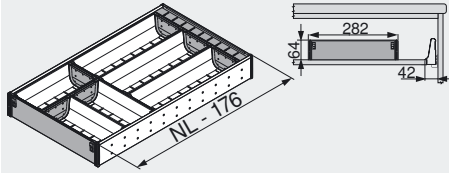

SPACE CORNER-Besteckeinsatz und Facheinteilung

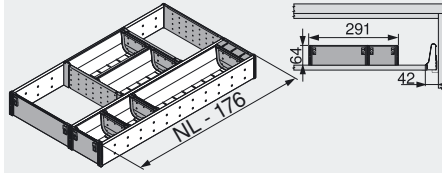

Messerhalter

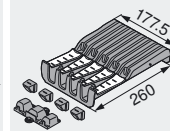

Geeignet für:

ZSI.xxxFI2N

ZSI.xxxFI3

ZSI.xxxKI3N

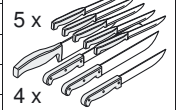

Nennlänge NL	Art.-Nr.
600 mm	ZSI.450BI3E
650 mm	ZSI.500BI3E

Nennlänge NL	Art.-Nr.
600 mm	ZSI.450MI3E
650 mm	ZSI.500MI3E

	Art.-Nr.
RAL 7037 staubgrau	ZSZ.02M0

Schalen

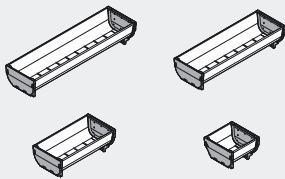

Flexible Querteiler

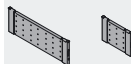

	Art.-Nr.
88 x 88 mm	ZSI.010SI
88 x 176 mm	ZSI.020SI
88 x 264 mm	ZSI.030SI
88 x 352 mm	ZSI.040SI

	Art.-Nr.
88 mm	ZSI.010Q
176 mm	ZSI.020Q

Planung

Für zusätzliche Einsätze:
Z.B. Messerblock aus Holz

Beispiel:
Korpusbreite 600 mm
Besteckeinsatz mit Facheinteilung ZSI.500KI4

X = lichte Korpusweite LW - 400 mm - 42 mm

Seitenhinweise

Übersicht – ORGA-LINE für TANDEMBOX

318

Empfehlung Sets für Sonder-Korpusbreiten

334

Montage und Verstellung

350

Weitere techn. Informationen

658

TANDEMBOX – Auszugssystem

▶ ORGA-LINE für TANDEMBOX

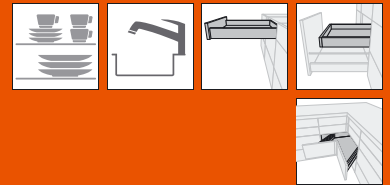

▶▶ Sets für Sonder-Korpusbreiten und Zubehör



Bestell-Empfehlung

Essbesteck

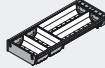
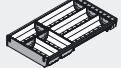
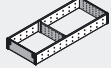

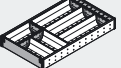

Korpusbreite KB (mm)	Sets							
								
275 - 299	1 x							
300 - 399	2 x							
400 - 449								
450 - 549	1 x	1 x						
550 - 799	1 x							
800 - 899								
900 - 999						1 x		
1000 - 1199						2 x		
≥ 1200				1 x	1 x	1 x		
SPACE CORNER							1 x	

Bei Bestellung jeweils xxx durch die gewünschte Nennlänge NL ersetzen (450, 500, 550, 600 und 650 mm)!

Bei Bestellung SPACE CORNER NL 600 mm = ZSI.450BI3E und NL 650 mm = ZSI.500BI3E!

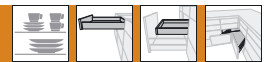
Kleinteile

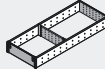
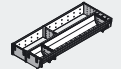
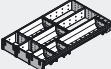
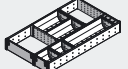

Korpusbreite KB (mm)	Sets						
							
275 - 449	1 x						
450 - 599							
600 - 799	1 x						
800 - 899							
900 - 999	1 x	1 x					
≥ 1000		1 x					
SPACE CORNER						1 x	

Bei Bestellung jeweils xxx durch die gewünschte Nennlänge NL ersetzen (450, 500, 550, 600 und 650 mm)!

Bei Bestellung SPACE CORNER NL 600 mm = ZSI.450MI3E und NL 650 mm = ZSI.500MI3E!

Reinigungsutensilien

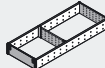
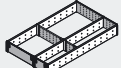
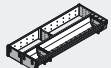
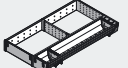

Korpusbreite KB (mm)	Sets						
							
600 - 799	1 x					1 x	
800 - 899						2 x	
900 - 999	1 x	1 x				1 x	
1000 - 1199		1 x				1 x	
≥ 1200				1 x		2 x	

Bei Bestellung jeweils xxx durch die gewünschte Nennlänge NL ersetzen (450, 500, 550, 600 und 650 mm)!

TANDEMBOX – Auszugssystem

► ORGA-LINE für TANDEMBOX



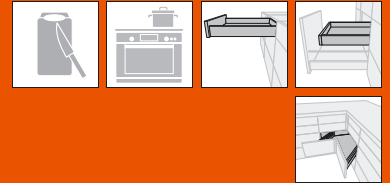

►► Sets für Sonder-Korpusbreiten und Zubehör

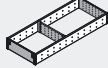

Bestell-Empfehlung

Arbeitsbesteck/Messer/Elektrokleingeräte

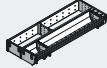
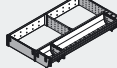

Korpusbreite KB (mm)	Sets						
							
	ZSI.xxxBI1N	ZSI.xxxFI2N	ZSI.xxxFI3	ZSI.xxxKI2N	ZSI.xxxKI3N	ZSZ.02M0	
275 - 449	1 x						
450 - 599		1 x				1 x	
600 - 799	1 x				1 x	1 x	
800 - 899					2 x	1 x	
900 - 999	1 x	1 x			1 x	1 x	
1000 - 1199		1 x		1 x	1 x	1 x	
≥ 1200			1 x		2 x	1 x	
SPACE CORNER			1 x			1 x	



Bei Bestellung jeweils xxx durch die gewünschte Nennlänge NL ersetzen (450, 500, 550, 600 und 650 mm)!

Bei Bestellung SPACE CORNER NL 600 mm = ZSI.450FI3 und NL 650 mm = ZSI.500FI3!

TANDEMBOX

Kochbesteck

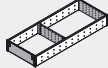

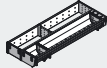
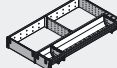
Korpusbreite KB (mm)	Sets							
								
	ZSI.xxxBI1N	ZSI.xxxFI2N	ZSI.xxxFI3	ZSI.xxxKI2N	ZSI.xxxKI3N			
600 - 799	1 x				1 x			
800 - 899					2 x			
900 - 999	1 x	1 x			1 x			
1000 - 1199		1 x		1 x	1 x			
≥ 1200			1 x		2 x			

Bei Bestellung jeweils xxx durch die gewünschte Nennlänge NL ersetzen (450, 500, 550, 600 und 650 mm)!

Seitenhinweise	
Übersicht – ORGA-LINE für TANDEMBOX	
ORGA-LINE-Sets/Zubehör	318
Planungsmaße	332
Montage und Verstellung	333
Weitere techn. Informationen	350
	658